

Light in your hands:
control our products
by Bluetooth.

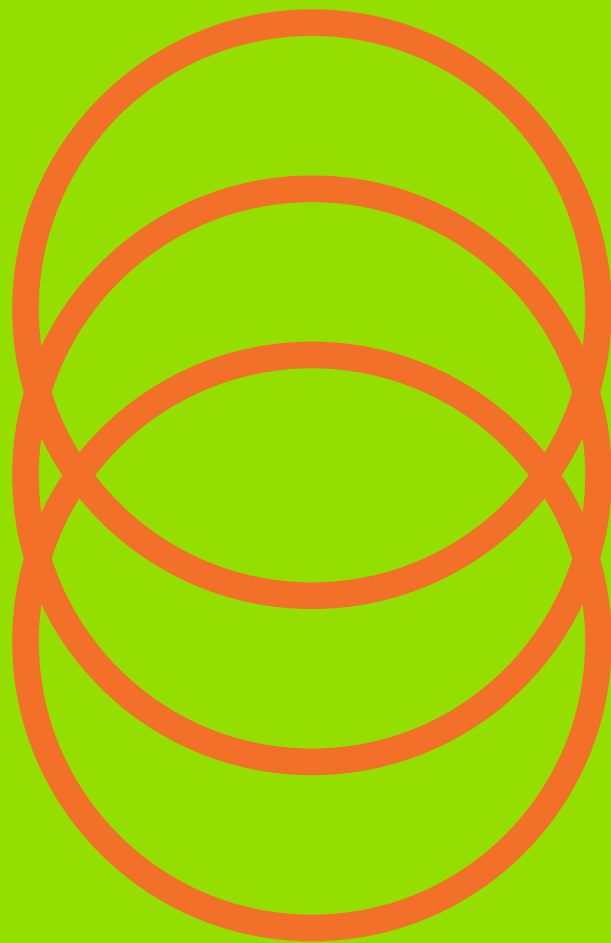

CAS▲MBI

Reggiani

Reggiani

Contents

Introduction	4
Individual control	17
Clustered control	29

EN We have integrated Bluetooth technology into our luminaire offering to deliver a truly customisable control solution. Adjust single luminaires or groups, set timers and scenes, even have your lighting adjust to the temperature of the ambient light outside.

IT Per offrire un sistema di controllo personalizzabile, abbiamo integrato la tecnologia Bluetooth nella nostra offerta. Regola l'illuminazione di un singolo o di un gruppo di apparecchi, imposta timer e scene, uniforma l'illuminazione interna alla luce dell'ambiente esterno.



Light in your hands

EN We have partnered with Casambi, the world's leader Bluetooth control technology in the lighting industry, to provide the most comprehensive, flexible and user focused lighting control. Turn your device into an all-in-one lighting control system by downloading the Casambi APP.

With just one tap on your device you can have the full control on your Reggiani products: adjust single luminaires or groups, set timers and scenes, swipe left to right to adjust the light temperature and set dimming levels.

IT Abbiamo collaborato con Casambi, il leader mondiale nella tecnologia Bluetooth per gli apparecchi di illuminazione, per fornire il sistema di controllo più completo, flessibile e user friendly. Trasforma il tuo dispositivo in un sistema Bluetooth all-in-one, semplicemente scaricando l'APP Casambi.

Con un solo tocco, hai la possibilità di avere il pieno controllo sui tuoi prodotti di illuminazione Reggiani: regola l'illuminazione di un singolo o di un gruppo di apparecchi, imposta timer ed ambientazioni, scorri da sinistra verso destra per regolare la temperatura colore ed impostare i livelli di dimmerazione.



EN The Casambi APP can be downloaded directly from the Apple App Store and Google Play Store and then personalized Reggiani.

IT L'APP Casambi può essere scaricata direttamente da Apple App Store e Google Play Store e successivamente personalizzata Reggiani.



EN Thanks to a simple installation procedure and an intuitive user interface, tailoring the lighting result in the office, retail or hospitality sector has never been easier. The Casambi App offers a wide range of functionalities, easy to access and use: set the color temperature based on your needs, manage your time by setting schedules and group products based on animations and scenes.

IT Grazie ad una semplice procedura di installazione e ad un'interfaccia user friendly, ottenere il risultato illuminotecnico desiderato in qualsiasi contesto, che sia un ufficio, un progetto retail o hospitality, non è mai stato così semplice. L'App Casambi offre una vasta gamma di funzionalità di facilissimo accesso ed uso: imposta la temperatura colore in base alle tue richieste, gestisci il tuo tempo programmando accensione e spegnimento e raggruppa i tuoi prodotti in base ad animazioni e scene.





Light color

EN Cruise the color spectrum.
The luminaire manufacturer defines the color range of their Casambi Ready product. The end user can play within these parameters, saving favorites in a color palette.

IT Esplora lo spettro di colori.
Mentre lo spettro di colori è definito in fase di produzione del prodotto, con un prodotto Casambi puoi giocare all'interno dei parametri impostati, salvando i preferiti in una tavolozza di colori.



Sunrise & sunset

EN Tune into nature.
By setting a lighting network's time zone and location in the app, Casambi units can calculate local sunrise/sunset times and adjust luminance levels or recall programmed lighting scenes accordingly.

IT Sintonizzati con la natura.
Impostando il fuso orario e la localizzazione della rete nell'app, le unità Casambi possono calcolare gli orari di alba/tramonto e programmare la corretta illuminazione di conseguenza.



Calendar & timer

EN Master time management.
Control your lighting according to pre-defined schedules. With the calendar and timer functionality, scenes and animations can be programmed to turn on and off based on bespoke needs.

IT Gestisci il tuo tempo.
Con la funzionalità calendario e timer, le scene e le animazioni possono essere programmate per accendersi e spegnersi in base alle esigenze personali.



Color temperature

EN Tweak the color temperature.
The luminaire manufacturer defines the color temperature limits of their Casambi Ready Tunable White luminaire. The Casambi App provides a slider for end users to pinpoint a specific color temperature within the range.

IT Modifica la temperatura di colore.
Semplicemente facendo swipe da sinistra verso destra è possibile modificare la temperatura di colore all'interno dei limiti predisposti in fase di produzione del prodotto.



Grouping

EN Choreograph your lighting.
Grouping luminaires in the Casambi App is very easy. It works with the same gestures used for grouping apps on your smart device. All grouped luminaires can be synchronously controlled and/or programmed for individual control.

IT Crea una configurazione per i tuoi apparecchi di illuminazione.
Raggruppare gli apparecchi nell'APP Casambi è semplicissimo. Tutti gli apparecchi di illuminazione raggruppati possono essere controllati in modo sincrono e/o programmati per il controllo individuale.



Scenes

EN Set the scene.
Create multiple lighting scenes to fit the changing needs within a space. These are created in the Casambi App and can be activated with the touch of a button. One luminaire can be used in several scenes.

IT Imposta una scena.
Crea più scene di illuminazione per soddisfare le mutevoli esigenze all'interno di uno spazio. Questi vengono creati nell'APP Casambi e possono essere attivati con il semplice tocco di un pulsante. Un apparecchio può essere utilizzato in più scene.



Animations

EN Create movement with light.
Animations are dynamic scenes in which it is possible for the lighting to fade from one scene into another. You can set the tempo, duration and cycles in the app.

IT Crea le tue animazioni.
Le animazioni sono scene dinamiche tramite cui l'illuminazione sfuma da una scena all'altra. Puoi impostare il tempo, la durata e i cicli nell'APP.



Gallery

EN Personalize your UI.
The Casambi App's Gallery feature allows you to upload photos of a space or a floor plan and mark the positions of the luminaires within the images. This helps you to visually identify and intuitively interact with them.

IT Personalizza la tua interfaccia utente.
La funzione Galleria dell'APP Casambi ti consente di caricare le foto di uno spazio o di una planimetria e di contrassegnare le posizioni degli apparecchi all'interno delle immagini. Questo ti aiuta a identificarli visivamente e interagire intuitivamente.



Control hierarchy

EN Enjoy conflict-free control.
Control hierarchy in the Casambi App facilitates cooperation between manual and automated lighting controls. You can pre-set overrides and modify the solution to fit the needed control logic.

IT Goditi il controllo senza conflitti.
La gerarchia di controllo nell'app Casambi facilita la cooperazione tra i controlli di illuminazione manuali e automatizzati.



Gateway

EN Gain remote-remote control.
You can set up integration with a Casambi Gateway to control your lights when you are not connected to the local Bluetooth network. A gateway connects to your Casambi lighting network via the internet.

IT Approfitta del controllo remoto.
Puoi configurare l'integrazione con un Gateway Casambi per controllare le tue luci quando non sei connesso alla rete Bluetooth locale. Un gateway si connette alla tua rete di illuminazione Casambi tramite Internet.



Scalability

EN Upscale your plans.
From a single-room set up it is easy and cost-effective to upscale to site-level functionality and even expand to outdoor applications. Casambi allows you to control multiple networks simultaneously.

IT Migliora i tuoi piani.
Da una configurazione a stanza singola è facile ed economico passare a configurazioni più ampie. Casambi ti permette di controllare più reti contemporaneamente.



Synchronization

EN One fine mesh.
Casambi devices form a mesh network, which is self-organizing and in constant synchronization. This means every single device contains the same full intelligence of the network and ensures no single point of failure. The more nodes that are installed, the more routes and the farther the signal can travel.

IT Una rete flessibile.
I dispositivi Casambi formano una rete flessibile, auto-organizzante e in costante sincronizzazione. Più nodi vengono installati, più percorsi si creano e più lontano può viaggiare il segnale.



Parameters

EN Be in the know.
Manufacturers can provide fixture parameters including, for example, product data, LED versions, current consumption, driver version, dimming curve or temperature limits. This info is uploaded to the cloud and can be viewed in the app by end users if desired.

IT Rimani aggiornato.
I produttori possono fornire i parametri dell'apparecchio inclusi, ad esempio, i dati del prodotto, le versioni dei LED, il consumo di corrente, la versione del driver, la curva di regolazione o i limiti di temperatura. Queste informazioni vengono caricate e visualizzate in APP.

Individual or cluster?

It's up to you

EN Control your products with total freedom - individually, in groups or in clusters. Casambi ready products included in our range can be controlled following these two main principles:

- Individual control and grouping (p.17)
- Clustered control and grouping (p.29)

IT Controlla i tuoi prodotti in totale libertà, singolarmente, in gruppi o in cluster. I prodotti con tecnologia Casambi all'interno del nostro assortimento possono essere controllati secondo due principi:

- Controllo individuale e raggruppamento (p.17)
- Controllo in cluster e raggruppamento (p.29)



Individual control and grouping

EN Individual control really means freedom.

Every Casambi enabled product can be controlled individually or organized in groups, resulting in a tailor made lighting solution, meeting the specific needs of the space and its users.

With individual control, you decide how to organize your lighting fixtures. Creating groups of individual controlled luminaires and developing scenes, allows more automation and granular control.



How to individually control a product? Reggiani products come with Bluetooth already integrated (H.), or can be paired with the Casambi device (0.26101.0000), or finally with the GhostDim device (H.30466.0021) for mains voltage track (220V). Visit the Guide (p.17) and let us take you through the different alternatives.

IT Il controllo individuale rappresenta la massima libertà.

Ogni prodotto abilitato Casambi può essere controllato singolarmente o organizzato in gruppi, dando vita a una soluzione di illuminazione su misura, che soddisfa le esigenze specifiche dello spazio e dei suoi utenti.

Con il controllo individuale, decidi tu come organizzare i tuoi apparecchi di illuminazione. La creazione di gruppi di singoli apparecchi di illuminazione controllati e lo sviluppo di scene consente una maggiore automazione e un controllo granulare.

Come controllare un prodotto singolarmente? I prodotti Reggiani possono avere Bluetooth integrato (H.), essere collegati al dispositivo Casambi (0.26101.0000) o al dispositivo GhostDim (H.30466.0021) per i binari ad alto voltaggio (220V). Visita la Guida (p.17) e fatti accompagnare tra le diverse alternative.

Description	Code
 Bluetooth integrated/ Bluetooth integrato	H._____
 CBU-ASD Casambi control unit for wireless / bluetooth control/ Unità di controllo Casambi CBU-ASD per controllo wireless/bluetooth	0.26101.0000
 GhostDim Casambi Bluetooth (1 Channel)/ GhostDim Casambi Bluetooth (1 Canale)	H.30466.0021

Individual control

^{EN} Products with integrated Bluetooth, or paired with their own Casambi device, can be controlled individually.

^{IT} I prodotti con Bluetooth integrato, o collegati al dispositivo Casambi, possono essere controllati individualmente.

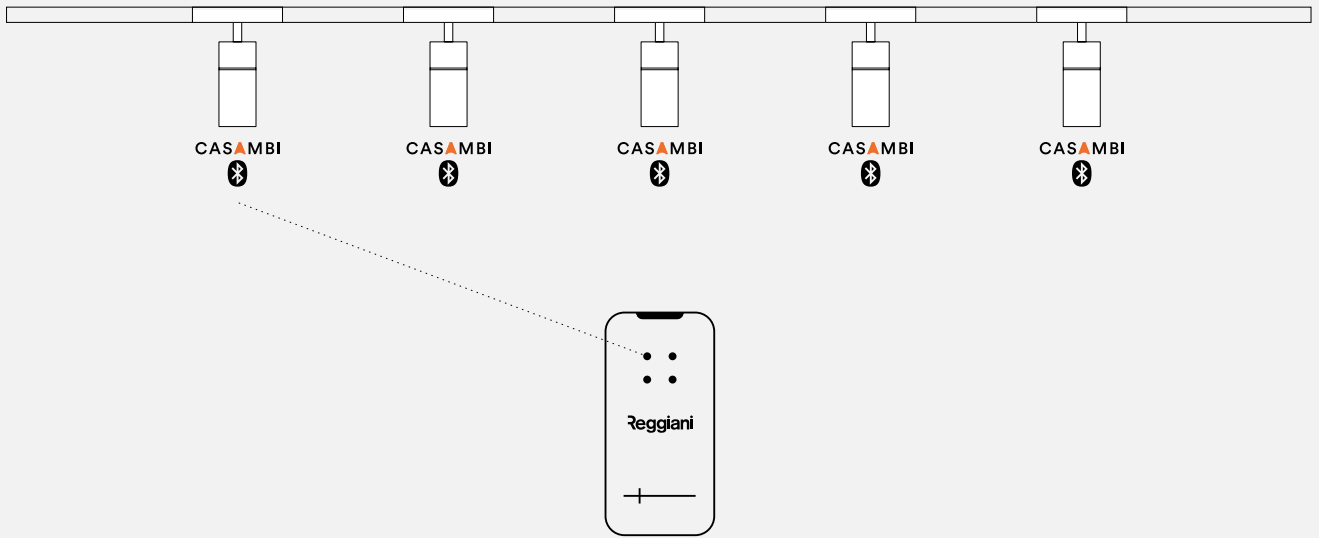

Grouping

^{EN} Products with integrated Bluetooth, or paired with their own Casambi device, can be grouped in specific groups, regardless of their application.

^{IT} I prodotti con Bluetooth integrato, o collegati al proprio dispositivo Casambi, possono essere raggruppati in specifici gruppi, qualunque sia la loro applicazione.

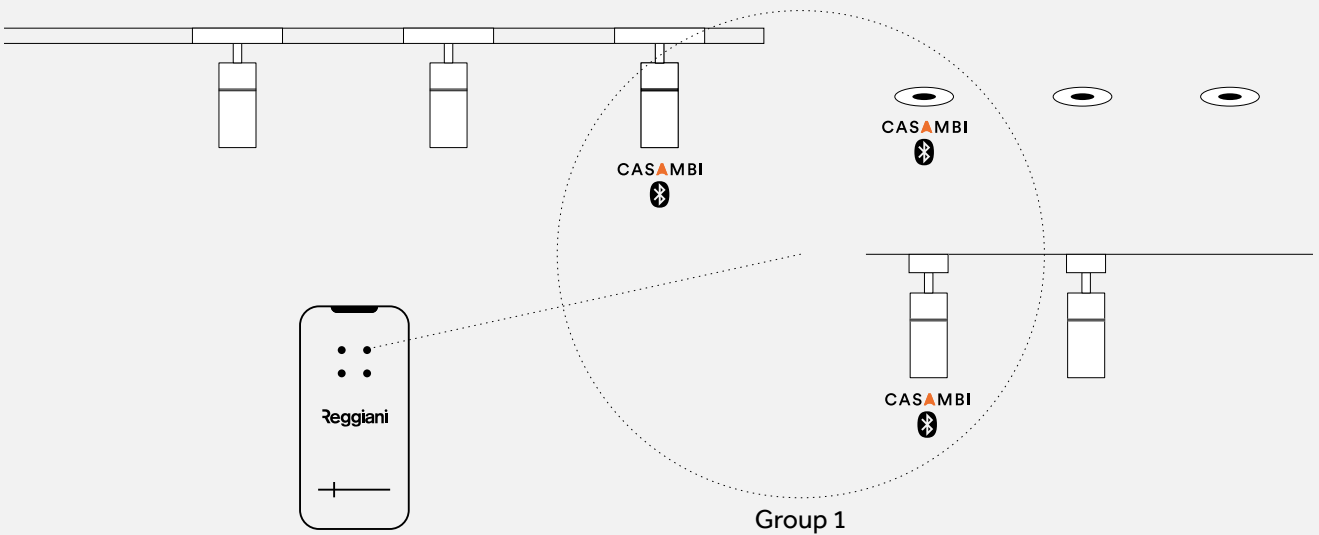

Cluster control and grouping

EN In addition to individual control, track mounted products (specifically 24V, 48V and 220V) can be controlled in cluster. By using a single "Casambi Bluetooth Track Control Device" (see below) you can control simultaneously up to 64 lighting fixtures mounted on the same track. When included in the same cluster, they will turn on and turn off, change the colour temperature, be dimmed and follow the same scene control in the same manner. To allow for more flexibility, products can be organized in up to 8 groups.

IT Oltre al controllo individuale, i prodotti a binario (24V, 48V, 220V nello specifico) possono essere controllati in cluster. Tramite un unico "Casambi Bluetooth track control device" (vedi sotto) puoi controllare contemporaneamente fino a 64 prodotti sul binario. Se sono raggruppati in un unico cluster, si accenderanno e spegneranno, cambieranno temperatura colore, saranno dimmerati e seguiranno lo stesso controllo della scena nello stesso modo. Per maggiore flessibilità, gli stessi prodotti potranno poi essere raggruppati fino ad un massimo di 8 gruppi.

	Description	Vdc	Code
	Casambi Bluetooth Track Control device - 220V/ Dispositivo di controllo Casambi Bluetooth per binario - 220V	220Vdc	H.26102.00XX
	Casambi Bluetooth Track Control device - 48V/ Dispositivo di controllo Casambi Bluetooth per binario - 48V	48Vdc	H.26104.00XX
	Casambi Bluetooth Track Control device - 24V/ Dispositivo di controllo Casambi Bluetooth per binario - 24V	24Vdc	H.26106.0021

Control up to 64 products in 1 group

^{EN} Control up to 64 fixtures simultaneously in one group.
^{IT} Controlla simultaneamente fino a 64 apparecchi in un unico gruppo.

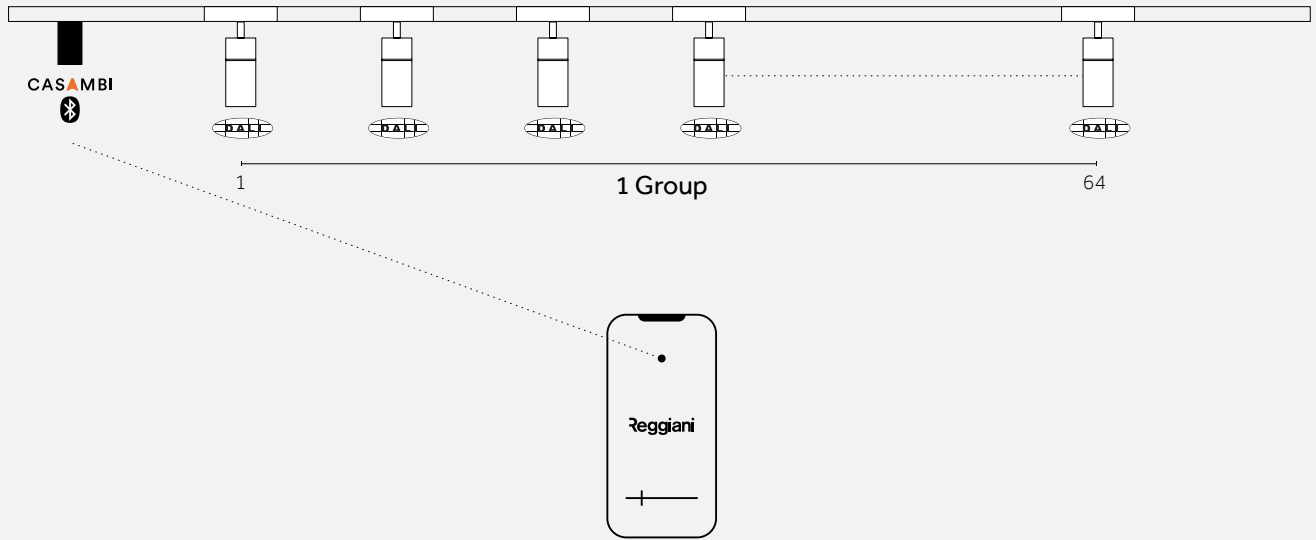

Control up to 64 products in up to 8 groups

^{EN} Control up to 64 fixtures in up to 8 groups, controlled as a cluster.
 Note: a group can also contain a single product.
^{IT} Controlla fino a 64 apparecchi divisi in massimo 8 gruppi, controllati come un cluster.
 Nota: un gruppo può essere formato anche da un solo prodotto.

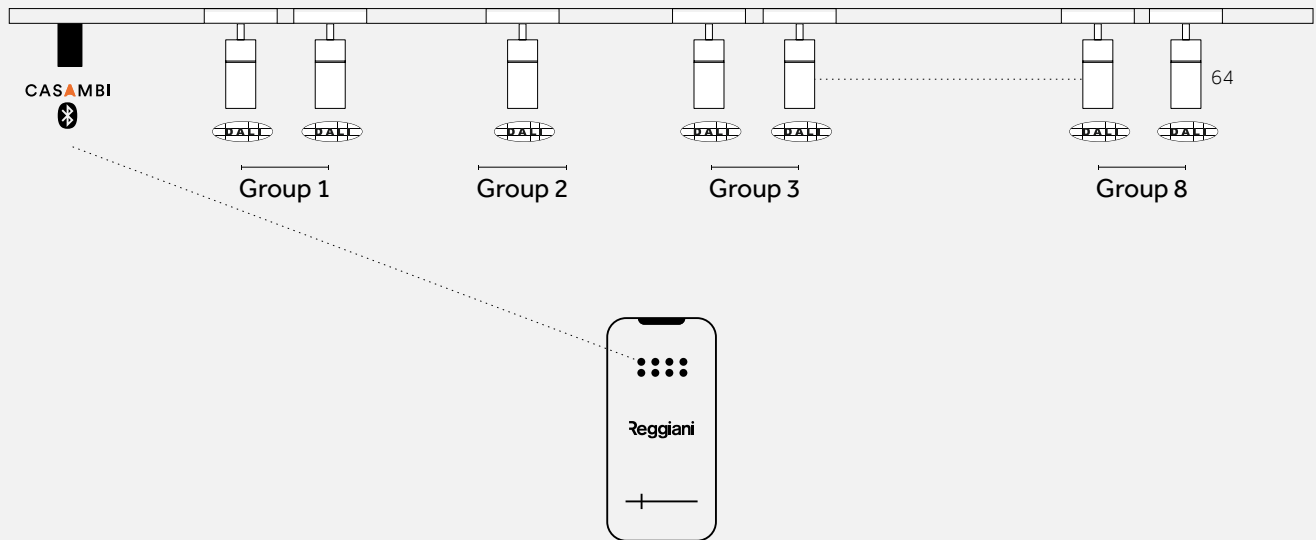

Individual

Recessed

Surface

Pendant

Mains voltage track

Low voltage track

Modular systems

Outdoors

Recessed

Products without DALI driver

^{EN} Pair the product (X.) with the DALI driver and add the Casambi device (0.26101.0000).
^{IT} Collega il prodotto (X.) ad un driver DALI ed aggiungi l'accessorio Casambi (0.26101.0000).



Mood

Roomer

Justy

Trybeca



Unit

Yori Recessed

Yori Semi-recessed

Bisio

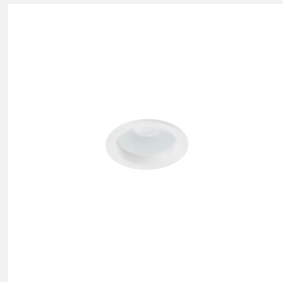

ReLow LED

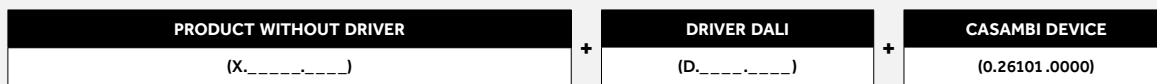
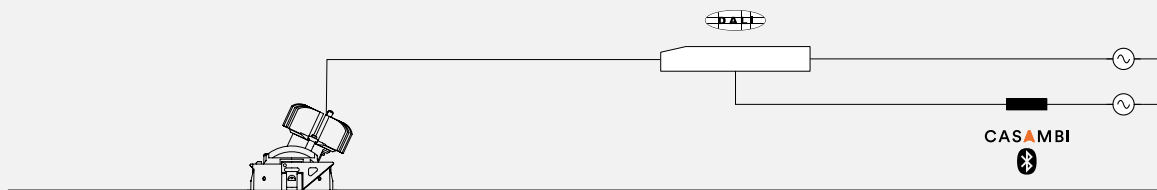

(Example: X.MP12B.HQ12 + D.30420.0000 + 0.26101.0000)

Products with driver DALI included

^{EN} Choose a product with DALI driver included (D.) and add the Casambi device (0.26101.0000).

^{IT} Scegli un prodotto con driver DALI incluso (D.) ed aggiungi l'accessorio Casambi (0.26101.0000).



Miled



Splyt Recessed

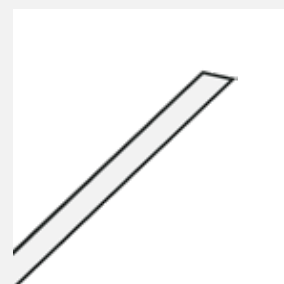

Yori Linear Recessed



PRODUCT WITH DRIVER (DALI)
(D._____.____.)

CASAMBI DEVICE
(0.26101.0000)

(Example: D.BH020.HQ12 + 0.26101.0000)

Products without driver

^{EN} Pair the product (X.) with the On-Off driver and add the Dimmer Bluetooth.

^{IT} Collega il prodotto (X.) ad un driver On-Off ed aggiungi il Dimmer Bluetooth.



Traceline Recessed
Traceline Deep Recessed
(-, L, T, +, □)



PRODUCT WITHOUT DRIVER
(X._____.____.)

DIMMER BLUETOOTH
(H._____.____.)

DRIVER ON-OFF
(O._____.____.)

(Example: X.CN32L.HCB0 + H.30847.0000 + 0.30820.0000)

Surface

Products without DALI driver

^{EN} Pair the product (X.) with the DALI driver and add the Casambi device (0.26101.0000).
^{IT} Collega il prodotto (X.) ad un driver DALI ed aggiungi l'accessorio Casambi (0.26101.0000).

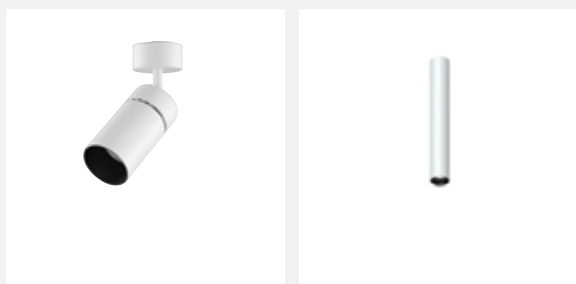

Yori Surface Base
 Yori Surface Base - Zoom
 Yori Surface Base - Magnetic

Yori Surface/Pendant - Ø22

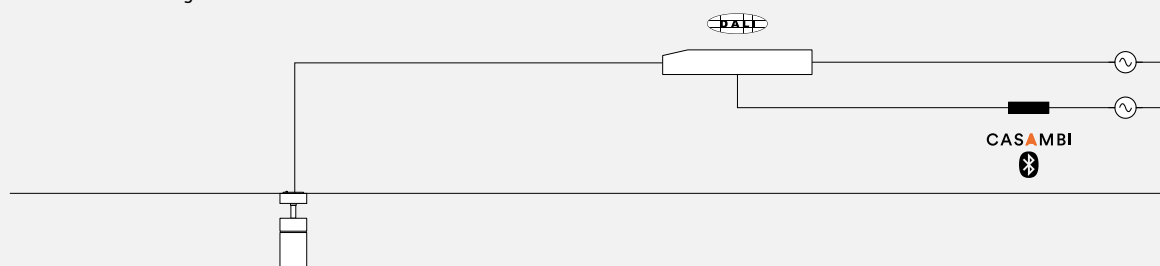

(Example: X.CP70B.HQ12 + 0.26101.0000)

Products with driver Bluetooth integrated

^{EN} When you choose a Bluetooth ready product (H.), you don't need to add anything.
^{IT} Quando scegli un prodotto con Bluetooth integrato (H.), non avrai bisogno di aggiungere altro.

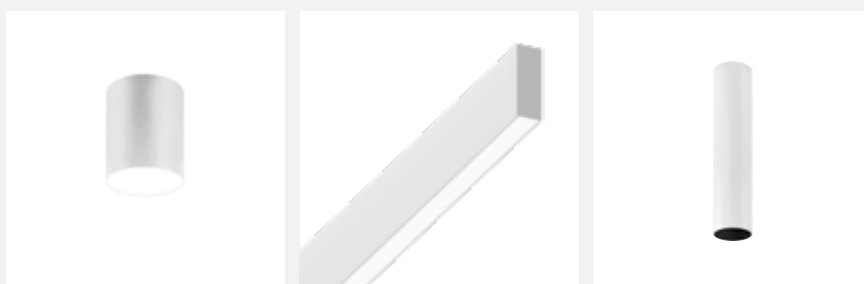

Trybeca Surface
On request

Traceline Surface/Pendant
 Traceline Pendant Direct/Indirect
 (-, L, T, +, □)

Yori Surface/Pendant
On request

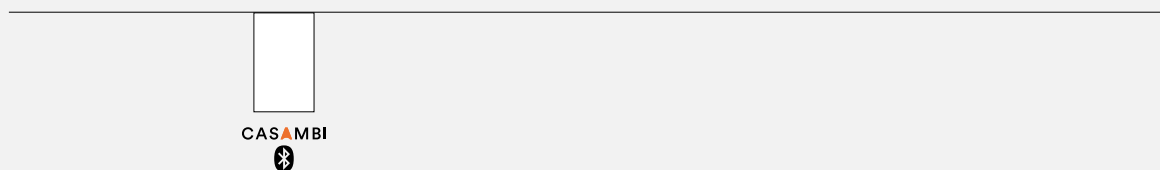

(Example: H.CN89L.HWB0)

Pendant

Products with driver Bluetooth integrated

^{EN} When you choose a Bluetooth ready product (H.), you don't need to add anything.

^{IT} Quando scegli un prodotto con Bluetooth integrato (H.), non avrai bisogno di aggiungere altro.



Lorosae

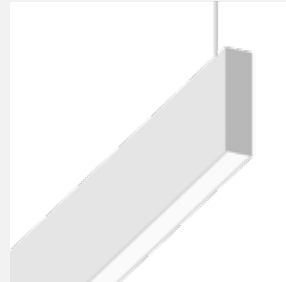

Traceline Pendant Direct/Indirect
(-, L, T, +, □)



Yori Surface/Pendant
Onrequest



PRODUCT WITH DRIVER / BLUETOOTH INTEGRATED

(H.)

(Example: H.B5270.HQ74)

Mains voltage track mounted luminaires (220V)

Products with driver (On-Off) included or not included

^{EN} Choose a product with On-Off driver included (0.) and add the GhostDim Casambi (H.30466.0021.____).

^{IT} Scegli un prodotto con driver On-Off incluso (0.) ed aggiungi il GhostDim Casambi (H.30466.0021.____).

^{EN} For products with the driver not included (X.), pair the product with an On-Off driver and add the GhostDim Casambi (H.30466.0021.____).

^{IT} Per i prodotti con il driver non incluso (X.), collega il prodotto ad un driver On-Off ed aggiungi il GhostDim Casambi (H.30466.0021.____).

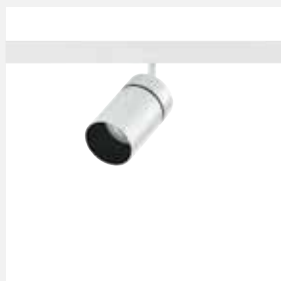

Yori Evo Ghostrack
Yori Evo Ghostrack Zoom
Yori Evo Ghostrack Pro



Yori Pendant Ghostrack



Incline

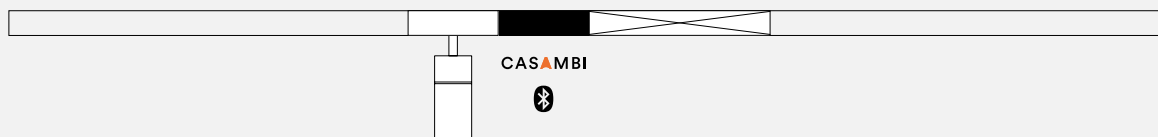

(Example: 0.1X.GH72B.HCB0 + H.30466.0021.250)

^{EN} Add the required driver current to the end of the GhostDim Casambi code.

^{IT} Aggiungi la corrente richiesta dal driver alla fine del codice del GhostDim Casambi.



(Example: X.1X.FH71B.HQB0 + H.30466.0021.350 + 0.30451.0000)

^{EN} Add the required driver current to the end of the GhostDim Casambi code.

^{IT} Aggiungi la corrente richiesta dal driver alla fine del codice del GhostDim Casambi.

^{EN} Note: GhostDim Casambi works also with Yori cluster configurations (2X / 3X / 4X)

^{IT} Nota: GhostDim Casambi funziona anche con configurazioni cluster Yori (2X / 3X / 4X)

Products with driver Bluetooth Integrated

^{EN} When you choose a Bluetooth ready product (H.), you don't need to add anything.

^{IT} Quando scegli un prodotto con Bluetooth integrato (H.), non avrai bisogno di aggiungere altro.



Yori Evo Box
Yori Evo Box - Zoom
Yori Evo Box - Pro

Yori Linear Adjustable



PRODUCT WITH DRIVER / BLUETOOTH INTEGRATED

(H._____)

(Example: H.FR92B.HQ12)

Low voltage track mounted luminaires (48V)

Products with driver Bluetooth integrated

^{EN} When you choose a Bluetooth ready product (H.), you don't need to add anything.

^{IT} Quando scegli un prodotto con Bluetooth integrato (H.), non avrai bisogno di aggiungere altro.

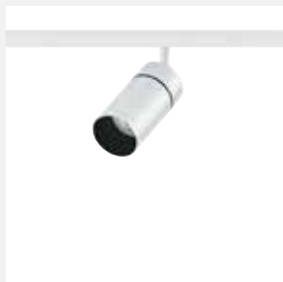

Yori Evo 48V
Yori Evo 48V - Zoom
Yori Evo 48V - Pro



Yori Pendant 48V



Yori Linear 48V / Opal
Yori Linear 48V / Prismatic
Yori Linear 48V / UGR -19



PRODUCT WITH DRIVER / BLUETOOTH INTEGRATED
(H.)

(Example: H.DN63H.NNB0)

Modular systems

Products with driver DALI not included

^{EN} Pair the product (X.) with the DALI driver and add the Casambi device (0.26101.0000).

^{IT} Collega il prodotto (X.) ad un driver DALI ed aggiungi l'accessorio Casambi (0.26101.0000).



Yori Edge

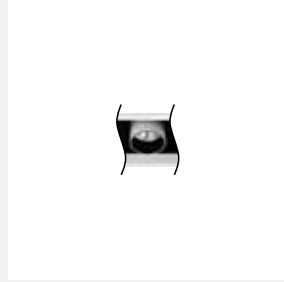

Unit Channel

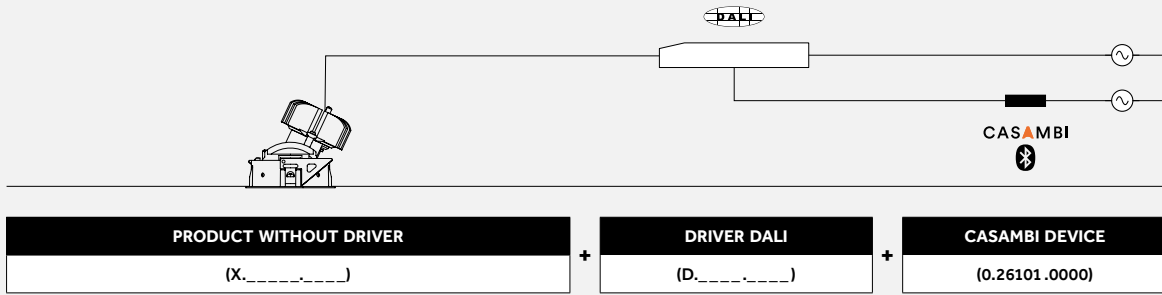

(Example: X.GL62B.HC12 + D.30360.0010 + 0.26101.0000)

Outdoors

Products with driver not included

^{EN} Pair the product (X.) with an On-Off driver, add the Dimmer DALI (D.30850.0000) and the Casambi device (0.26101.0000).

^{IT} Collega il prodotto (X.) ad un driver On-Off, aggiungi il Dimmer DALI (D.30850.0000) e l'accessorio Casambi (0.26101.0000).



Yori IP66

Yori IP66 Surface/Pendant

Yori IP66 Wall

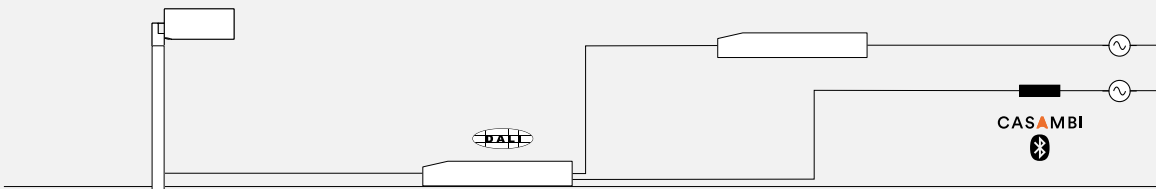

PRODUCT WITHOUT DRIVER	DIMMER - DALI	DRIVER - ON-OFF	CASAMBI DEVICE
(X._____) +	(D.30850.0000) +	(0.30524.0000) +	(0.26101.0000)

Example: X.BR00A.HN8C + D.30850.0000 + 0.30524.0000 + 0.26101.0000

Products with driver Bluetooth integrated

^{EN} When you choose a Bluetooth ready product (H.), you don't need to add anything.
^{IT} Quando scegli un prodotto con Bluetooth integrato (H.), non avrai bisogno di aggiungere altro.



Cells

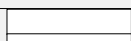

PRODUCT WITH DRIVER / BLUETOOTH INTEGRATED

(H.)

(Example: H.BG040.NNQ0)

Cluster

Mains voltage track

Low voltage track

Mains voltage track mounted luminaires (220V) - Cluster

Products with driver DALI included or not included

^{EN} Choose a product with DALI driver included (D.) and add the Casambi track control device directly to the track (H.26102.0021).

^{IT} Scegli un prodotto con driver DALI incluso (D.) ed aggiungi il sistema di controllo per binari Casambi direttamente al binario (H.26102.0021).

^{EN} Pair the product (X.) with the DALI driver and add the Casambi track control device directly to the track (H.26102.0021).

^{IT} Collega il prodotto (X.) ad un driver DALI ed aggiungi il sistema di controllo per binari Casambi direttamente al binario (H.26102.0021).

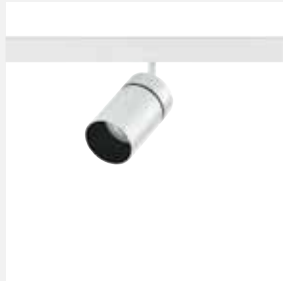

Yori Evo Ghostrack
Yori Evo Ghostrack - Zoom
Yori Evo Ghostrack - Pro



Yori Pendant Ghostrack



Incline

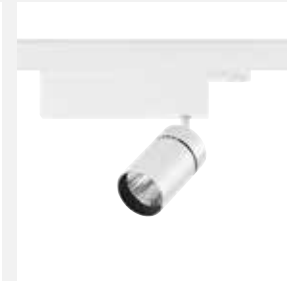

Yori Evo Box
Yori Evo Box - Zoom
Yori Evo Box - Pro



Yori Linear Adjustable



Splyt Track

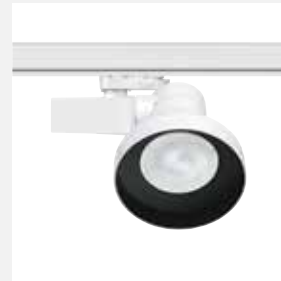

Varios

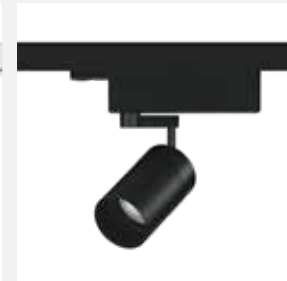

Yori Slot



Roll IOS

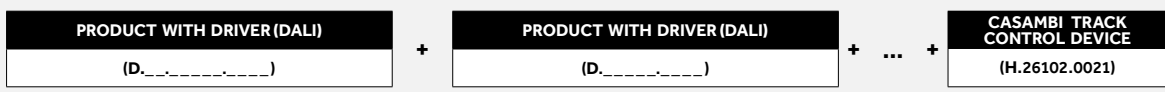
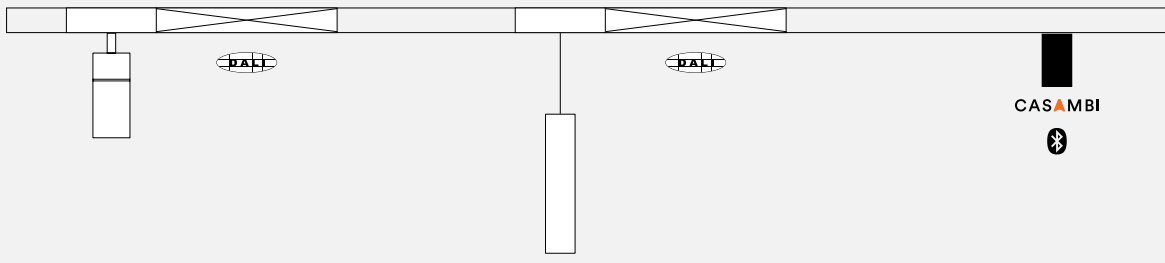

(Example: D.1X.GH72B.HCB0 + D.LM72B.HQB0 + ... + H.26102.0021)

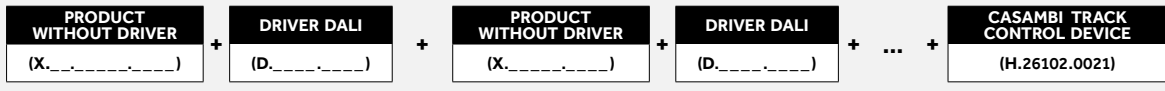

(Example: X.1X.CR62B.HQB0 + D.30466.0021 + X.FM71B.HWB0 + D.30466.0021 + ... + H.26102.0021)

^{EN} Note: Casambi Track Control device works also with Yori cluster configurations (2X / 3X / 4X)
^{IT} Nota: Casambi Track Control funziona anche con configurazioni cluster Yori (2X / 3X / 4X)

Low voltage track mounted luminaires (48V) - Cluster

For products with driver DALI included

^{EN} Choose a product with DALI driver included (D.) and add the Casambi track control device directly to the track (H.26104.0021).

^{IT} Scegli un prodotto con driver DALI incluso (D.) ed aggiungi il sistema di controllo per binari Casambi direttamente al binario (H.26104.0021).

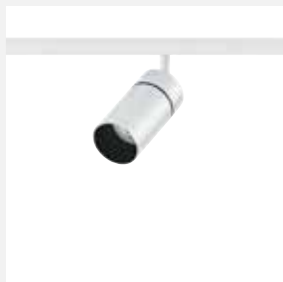

Yori Evo 48V
Yori Evo 48V - Zoom
Yori Evo 48V - Pro



Yori Pendant 48V



Yori Linear 48V / Opal
Yori Linear 48V / Prismatic
Yori Linear 48V / UGR -19

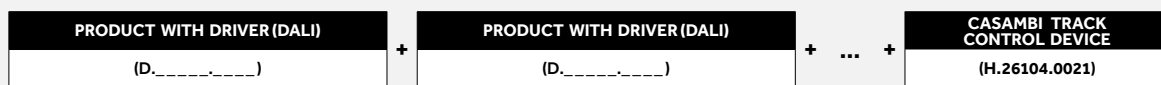
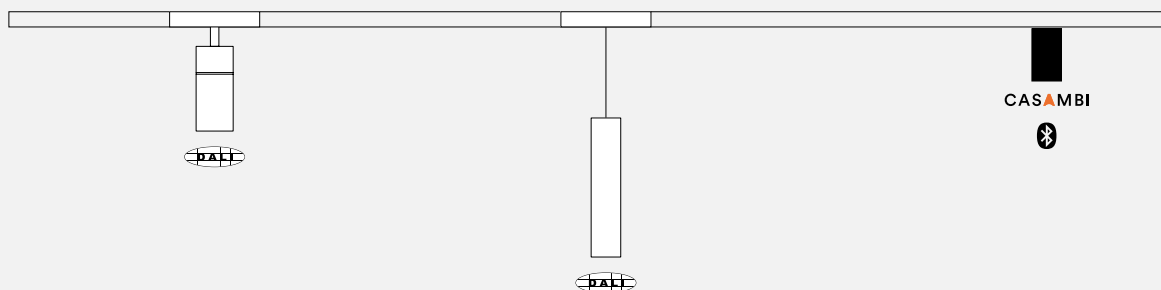

(Example: D.BN60B.HQB0 + D.TN61B.HQB0 + H.26104.0021)

Low voltage track mounted luminaires (24V) - Cluster

For products with DALI driver included

^{EN} Choose a product with DALI driver included (D.) and add the Casambi track control device (H.26106.0021) directly to the track.
^{IT} Scegli un prodotto con driver DALI incluso (D.) ed aggiungi il sistema di controllo per binari Casambi (H.26106.0021) direttamente al binario.

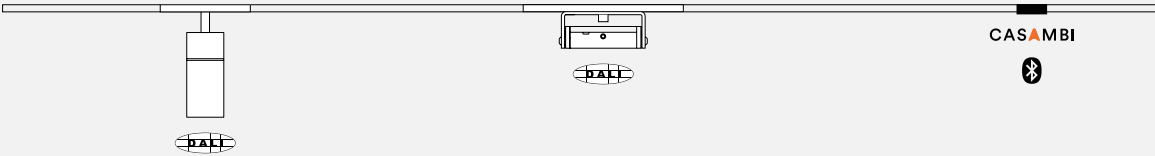

(Example: D.BS41B.HNB0 + D.TN61B.HQB0 + H.26106.0021)

Reggiani

©

2023

Reggiani S.p.A. Illuminazione
All rights reserved

Art direction

Reggiani

Graphic design

Reggiani

Pictures

Reggiani

Lens visual

^{EN} Reggiani S.p.A. Illuminazione reserves the right to make technical, design and size changes at any time, without prior notice. Total or partial reproduction of this document is prohibited. Luminaire sizes are given in millimetres. All technical and design innovations are patented. Watts and lumens refer to the nominal values of the LED source; for photometric data and lumen output of the luminaires, visit www.reggiani.net

^{IT} Reggiani S.p.A. Illuminazione si riserva la facoltà di effettuare in qualsiasi momento senza preavviso, variazioni tecniche, formali e dimensionali. Sono vietate le riproduzioni anche parziali del presente documento. Le dimensioni degli apparecchi sono espresse in millimetri. Tutte le innovazioni tecniche e formali sono coperte da brevetto. Watt e lumen fanno riferimento ai valori nominali della sorgente LED, per i dati fotometrici e i lumen output degli apparecchi visitare www.reggiani.net

HEADQUARTERS

Reggiani S.p.A. Illuminazione

Viale Monza 16
20845 Sovico (MB), Italy
T. (+39) 039 20711
contact@reggiani.net



Reggiani

www.reggiani.net

[#theilluminationcollective](https://twitter.com/theilluminationcollective)